

Description

The SDG-8612 and SDG-8614 are carrier-class, dual-band, Wi-Fi 6, 2.5G routers designed to deliver top-end Wi-Fi 6 performance, multi-gigabit throughput, and advanced service delivery capabilities.

Figure 1: SDG-8612 and SDG-8614 Wi-Fi 6 2.5G Routers – Front View

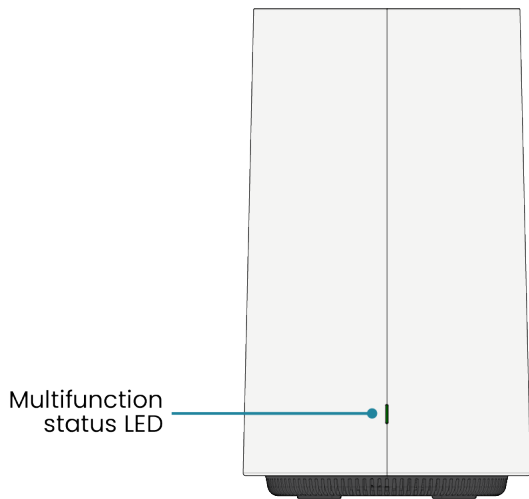

The SDG-8612 and SDG-8614 come with pre-loaded software packages, as shown in this table.

Table 1: SDG-8612 and SDG-8614 Variants

Description	P/N
SDG-8612 with SmartOS	17600070FxS
SDG-8612 with PlumeOS DHCP	17600070FxPD
SDG-8612 with PlumeOS PPPoE	17600070FxPP
SDG-8614 with SmartOS	17600071FxS
SDG-8614 with PlumeOS DHCP	17600071FxPD
SDG-8614 with PlumeOS PPPoE	17600071FxPP



WARNING

A warning indicates a hazard that, if not avoided, could result in death, injury, or serious property damage.



CAUTION

A caution indicates a hazard that, if not avoided, could result in service interruption, damage to the equipment, or minor property damage.



NOTE

A note highlights additional, but important, information or features.

Figure 2: SDG-8612 and SDG-8614— Rear View

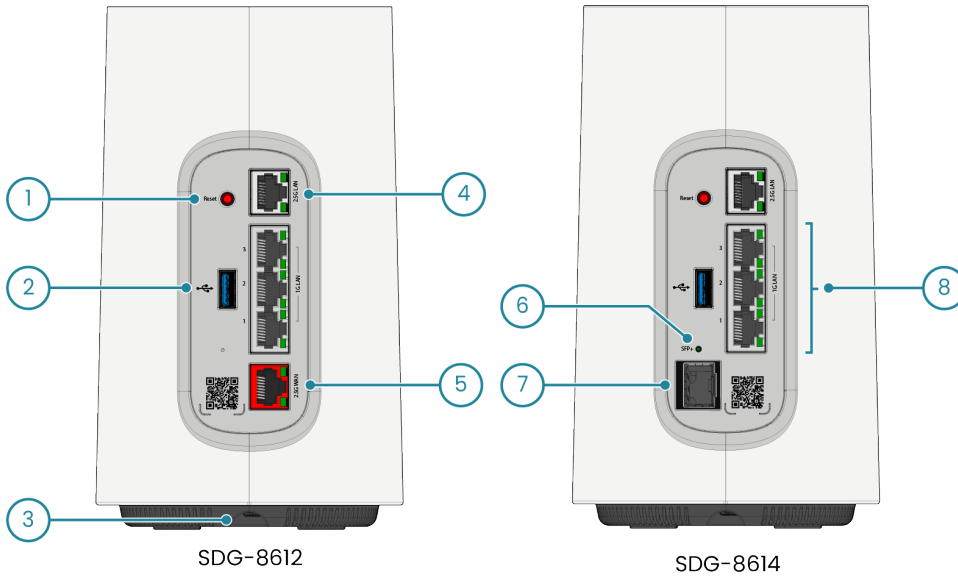

Callout	Description
1	Reset button
2	USB 3.0 host port (Type A) used for the direct connection of a USB memory stick or an Adtran-approved LTE communication module
3	Routing hole for power cable and USB-C powering connector
4	One 2.5 GbE LAN port (RJ45) and LEDs
5	One 2.5 GbE WAN port (RJ45) and LEDs – SDG-8612 only
6	SFP Status LED – SDG-8614 only
7	One SFP+ cage for WAN – SDG-8614 only
8	Three 1 GbE LAN ports (RJ45) and LEDs

CAUTION
 Due to compliance certification requirements, use only pluggable optics supplied by Adtran. Adtran cannot certify system integrity with other pluggable optics.

Installation

After you unpack the unit, inspect it for damage. If you notice any damage, file a claim with the carrier and then contact Adtran. For more information, see [Warranty](#).

Installation Guidelines	3
Shipment Contents	3
Required Equipment	3
Step 1: Installing the SDG-8612 and SDG-8614	4
Step 2: Connecting the Power	6
Step 3: Connecting the Subscriber Services	6
Step 4: Setting Up	8
Step 5: Logging In	8

Installation Guidelines



NOTE

See the national, state, and local electrical codes for the requirements for power, grounding, wiring, and installation methods.

- Read all warnings and cautions before you install or service the SDG-8612 and SDG-8614.
- Ensure that the SDG-8612 and SDG-8614 are not located in direct sunlight or next to any thermal obstructions.
- Ensure that the SDG-8612 and SDG-8614 do not come in contact with water or other liquids.
- For the optional wall-mounting kit, the screws and anchors are intended for drywall mounting only. For mounting on other surfaces, obtain the appropriate mounting hardware and follow the provided instructions.



CAUTION

This product is subject to electrostatic damage or a decrease in reliability. Handling precautions are required.



CAUTION

This product is intended for indoor use only. Ethernet cables, USB cables, and attached equipment are intended for use within the same building with equipotential bonding, and not intended to be placed in separate buildings or structures. The Ethernet cables can be safely connected to network wiring that is distributed within the building (Building Wiring per IEC 62368-1). The USB interfaces are not intended for distribution on building wiring. Failure to deploy as described could result in permanent damage from lightning or other electrical events and voids the warranty.

Table 2 shows the recommended minimum distance between the device and household appliances to reduce interference.

Table 2: Recommended Distance Between the Device and Household Appliances

Household Appliance	Minimum Distance
Microwave ovens	30 feet / 9 meters
Baby monitor – analog	20 feet / 6 meters
Baby monitor – digital	40 feet / 12 meters
Cordless phone – analog	20 feet / 6 meters
Cordless phone – digital	30 feet / 9 meters
Bluetooth devices	20 feet / 6 meters
ZigBee	20 feet / 6 meters

Shipment Contents

- SDG-8612 or SDG-8614 Wi-Fi 6 router
- 15 VDC power adapter (USB-C)
- Ethernet cable
- Quick Install Guide

Required Equipment

In addition to standard technician tools, use this equipment to install the SDG-8612 and SDG-8614:

- Optical power meter with wavelength filtering
- Fiberscope or videoscope
- Assorted tie wraps for securing cabling and wiring
- ODC fiber cleaning tool
- Appropriate fiber-optic cable for optical connection

- #2 Phillips screwdriver
- Drill
- Optional wall-mounting kit (P/N 17600201F1), which includes:
 - SDG Wall Mount M mounting bracket
 - Hook and loop fastener strap
 - 2x M4x50 mm screws and wall anchors
- 6 mm drill bit – for wall mounting to dry wall
- Hammer – for wall mounting to dry wall
- Appropriate size drill bit and screws – for wall mounting to other surfaces

Step 1: Installing the SDG-8612 and SDG-8614

Follow one of these procedures to install the SDG-8612 and SDG-8614:

Desktop Installation	4
Wall-Mount Installation	4



NOTE

Route and secure the cables in a manner that prevents damage.

Desktop Installation

You can locate the SDG-8612 and SDG-8614 on a desktop or table, but first ensure that the location meets the requirements listed in [Installation Guidelines](#).

Wall-Mount Installation

1. Determine the location for the SDG, and ensure that the LEDs are visible.
2. Assemble the mount by snapping the pieces together, as shown in this figure.

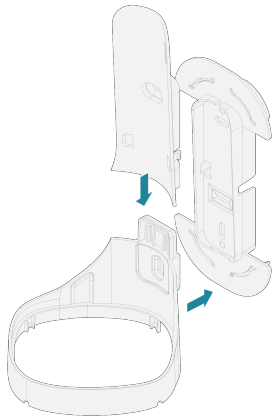

3. Use the keyholes on the wall-mount kit as a template and mark the wall accordingly.

4. To fasten the wall-mount kit to dry wall:
 - a. Use a 6 mm drill bit to drill the mounting holes into the wall.
 - b. Use a hammer to lightly tap the included wall anchors into the drilled holes until they are flush with the wall.
 - c. Thread the hook and loop fastener strap through the slots on the top of the mount.
 - d. Align the holes in the wall mount with the anchors in the wall.

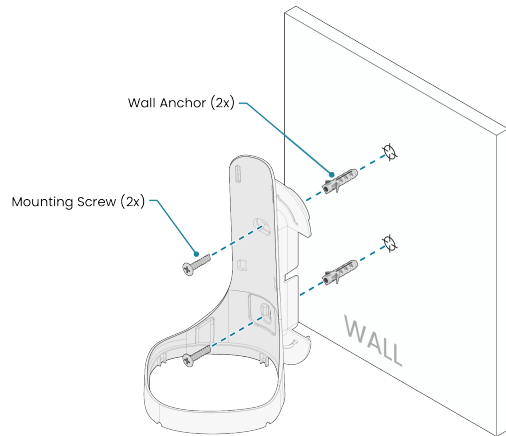

- e. Use the screwdriver to install two screws (included) into the anchors. Do not overtighten.
5. To fasten the wall-mount kit to other surfaces:
 - a. Obtain screws designed for your desired surface.
 - b. Use an appropriate size drill bit to drill pilot holes, if applicable.
 - c. Thread the hook and loop fastener strap through the slots on the top of the mount.
 - d. Align the holes in the wall mount with either the pilot holes or the marks you made on the wall in step 3.
 - e. Use the screwdriver and two appropriate screws to secure the wall mount to the wall.
6. Insert the SDG into the wall mount, base first, and then secure the device at the top with the hook and loop fastener strap.

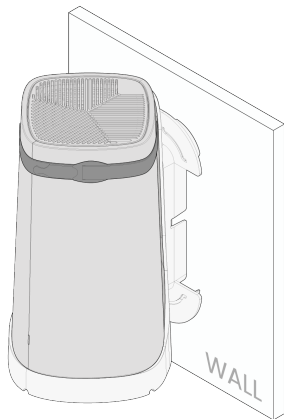

Step 2: Connecting the Power

The SDG-8612 and SDG-8614 ship with a region-specific AC to USB-C power adapter: North America, United Kingdom, European Union, and Australia/New Zealand. You connect the power adapter to the USB-C power input connector located on the bottom of the SDG.

1. Plug the provided USB-C power adapter into the USB-C Power In connection on the bottom of the SDG-8612 and SDG-8614.

Figure 3: SDG Bottom View

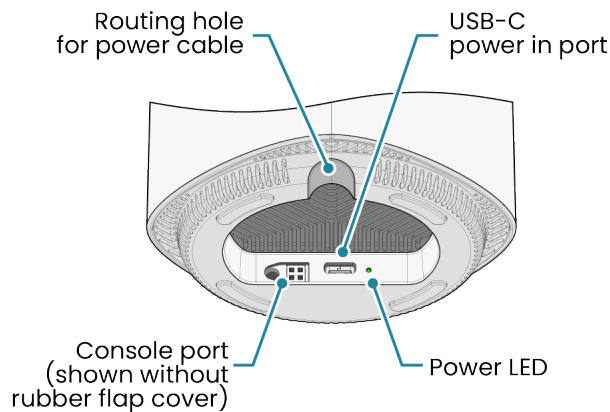

NOTE

Only a qualified technician can use the console port located on the bottom of the SDG to troubleshoot and repair the device.

2. Connect the power adapter to a standard 100 to 240 VAC outlet. The SDG begins powering up immediately as the SDG-8612 and SDG-8614 has no on/off power switch.
3. Verify that the Power LED is green, indicating that the SDG-8612 and SDG-8614 is receiving power. If the LED is red, the unit is receiving an incorrect amount of power.

The Multifunction Status LED should be lit on the front of the device, as described in [LEDs](#).



NOTE

Adtran recommends only using the DC power adapter that is provided with the unit.



CAUTION

For United States and Canada applications, the DC power adapter must be an NRTL Listed LPS power supply. For International applications, the DC power adapter must be an LPS power supply, specifically approved for that country.

Step 3: Connecting the Subscriber Services

These subscriber connections are available on the SDG-8612 and SDG-8614 and are shown in [Figure 2](#):

- 2.5 GbE WAN port (RJ45 connector) (SDG-8612 only).
- SFP+ cage – WAN port (SDG-8614). Maximum power output capability is 2.7 W.
- 2.5 GbE LAN port (RJ45 connector).
- Three 1 GbE LAN ports (RJ45 connector).
- USB 3.0 host port (Type A connector).



NOTE

Route and secure the fiber and cables in a manner that prevents damage.

Connecting the Ethernet Ports

To connect the Ethernet ports:

1. Insert the Category 5e (or higher) Ethernet cable coming from the service provider Ethernet port into the 2.5G WAN port until you hear an audible click.
2. Insert one end of a Category 5e (or higher) Ethernet cable into the appropriate LAN port until you hear an audible click. The port you choose should be compatible with your local device.
3. Connect the other end to any local device requiring wired Ethernet service.

Installing the Pluggable Optics and Connecting the Optical Cables



CAUTION

Do not look into the ends of optical fibers. Exposure to invisible laser radiation can cause serious retinal damage or even blindness. Before you handle optical fibers, verify the optical source is disabled using an optical power meter.



CAUTION

- Use caution when installing pluggable optics and optical fiber cables so you do not damage the optical fiber cable. The optical fiber cable should not have a bend radius smaller than one inch or 25.4 millimeters.
- Do not remove the protective dust cover from the pluggable optic until you are ready to connect the fiber optic cable.
- Due to compliance certification requirements, use only SFP+ pluggable optics approved by Adtran. Adtran cannot certify system integrity with other pluggable optics and cables. See the Adtran Pluggable Optics Compatibility Matrix (online tool, see www.adtran.com/pluggableoptics).



NOTE

For this procedure, ensure that:

- The pluggable optics are installed correctly.
- The fiber-optic cable ends and pluggable optic receptacles are properly inspected and cleaned.

To install an SFP+ into the SDG-8614:

1. Verify that you are properly connected to an appropriate ESD ground connection using an anti-static wrist strap or heel strap.
2. Remove the pluggable optic from its packaging and inspect the connectors for damage. If you find any damage, do not use this pluggable optic. Contact Adtran Technical Support for assistance. Do not attempt to repair it yourself.
3. Ensure that the latch on the pluggable optic is closed.
4. Insert the pluggable optic into the SFP cage until you hear an audible click.
5. Select the correct fiber cable types.
6. Prepare each cable:
 - a. Remove the protective cap from one end of the fiber, and the dust plug from the pluggable optic.
 - b. Inspect the fiber connector for damage. If you find any damage, replace the cable.
 - c. Clean the fiber end and pluggable optic receptacle using a standard cleaning kit. Be careful not to contaminate the surfaces after cleaning.
7. Insert the cable into the pluggable optic.
8. Repeat this section as appropriate to connect the other end.
9. Route and secure the fiber cables appropriately to prevent damage.
10. As you complete each connection, check the status LEDs to verify the links are valid. See [LEDs](#) for more information.



NOTE

- Use the pluggable optic latch only when you remove the pluggable optic from the SDG. Rotate the latch away from the port during removal. The pluggable optic should easily slide out of the cage.
- Only CDRH certified laser class I (1) pluggable optics must be used when connecting an pluggable optic to the SFP+ cage. Do not remove the protective dust cover from the SFP+ until the fiber optic cable is ready to be connected.

Connecting the USB Port

The USB 3.0 host port is used for the direct connection of a USB memory stick or an Adtran-approved LTE communication module.

Step 4: Setting Up

The SDG-8612 and SDG-8614 ships with two possible firmware options:

Setting up with PlumeOS	8
Setting up with SmartOS	8

Setting up with PlumeOS

For devices with PlumeOS installed, you need to download and install the HomePass Smartphone app by Plume. This app can be found in the Google Play Store or the Apple App Store. The workflow for initializing an Adtran SDG device differs slightly from other Plume enabled devices. See the *PlumeOS User Guide* or the HomePass app for quick setup instructions.

Setting up with SmartOS

For devices with SmartOS installed, scan the QR code labeled *Wi-Fi Quick Start* located on the back of the unit. You will be presented with a series of self-guided steps to choose your account password, select the gateway or access point mode, and configure the Wi-Fi SSID and passphrase. The specified account password will be used when initially logging into the GUI on the SDG device.

Step 5: Logging In

You use a browser-based GUI to manually configure the SDG-8612 and SDG-8614. These steps describe how to connect and login to the device using SmartOS:

1. Ensure your computer is connected to the SDG-8612 and SDG-8614 either using Wi-Fi or the Ethernet connection to the LAN port.



NOTE

This process will fail if your computer is connected to the WAN port.

2. Configure your computer network interface to acquire an IP address automatically using DHCP.
3. Open a web browser and enter **http://router** or **http://setup**. A sign-in page appears. If you are unable to connect to the SDG-8612 and SDG-8614 using either of these shortcuts, you can also enter the IP address of the unit. The default IP address is **192.168.1.1**.
4. Enter the default username (**admin**) and password. The password is the account password that was specified during the quick setup.



NOTE

If you have forgotten the password for this device, select **Forgot password?** and follow the instructions to reset the gateway configuration to the factory defaults.

5. Select **Sign In**. The Dashboard page appears, showing data about the system.



NOTE

If you are using the Intellifi MeshView solution, use the set up procedures found in the Intellifi Mobile App.

LEDs

When the SDG-8612 and SDG-8614 first power up, they perform self-tests. When the tests are complete, the LEDs display the device status.

Multifunction Status LED for SmartOS

The Multifunction Status LED on the front indicates the status of the device while running SmartOS. The LEDs appear in order of operation.

Color	LED State	Indication
Initial Set Up		
Blue	Solid	Cold boot
Red	Pulsing	Reboot and system upgrade (persists over uboot)
Green	Pulsing	Linux booting up
Light blue	Pulsing	Quick start
White	Solid	Controller WAN up, Internet
Amber	Solid	Controller WAN down, no Internet
Satellite Set Up		
Purple	Pulsing	Satellite set up
White	Solid	Satellite up
Red	Pulsing	Satellite up, fair signal
Amber	Pulsing	Satellite up, poor signal
White	Pulsing	Reverting

Multifunction Status LED for PlumeOS

The Multifunction Status LED on the front indicates the status of the device while running PlumeOS.

Color	LED State	Indication
Red	Short pulse	Plume error or hardware error
Green	Long pulse	Connecting
White	Long pulse	Connection failure
Blue	Short pulse	WPS/Bluetooth connecting
Green	Blinking	Locating a device
Green	Blinking	Optimizing
Off	Off	Connected

Ethernet Status LEDs

The Ethernet Status LEDs indicate the status of the Ethernet interfaces.

Port	Location and Color	Indication
2.5G WAN	Top, Green	Speed is 2.5 Gbps
2.5G LAN	Bottom, Green	Speed is 1 Gbps
	Bottom, Amber	Speed is 100 Mbps
1G LAN	Top, Amber	Speed is 10 to 100 Mbps
	Bottom, Green	Speed is 1 Gbps

SFP Status LED — SDG-8614 only

When the SFP fiber connection is active, the SFP Status LED indicates the status of fiber connectivity.

Color	LED State	Indication
Green	Solid	Loss of signal (LOS) is cleared
Red	Solid	LOS is set

Reset Button

If you need to reboot the SDG-8612 and SDG-8614, press the Reset button for less than 5 seconds.



WARNING

If you press the Reset button for longer than 5 seconds, the SDG-8612 and SDG-8614 resets to factory defaults.

Specifications

Electrical

Power is provided by a region specific AC to 15 VDC power adapter (USB-C) that is included with the SDG-8612 and SDG-8614. The nominal output is 15 VDC \pm 5% with a maximum current rating of 3.0 Amps.



NOTE

Adtran strongly suggests that the power supply (a 5.9-foot [1.8 m] power cord) included with the SDG-8612 and SDG-8614 be connected to a surge suppressor device which can have its own extension cable. The surge protection device should provide L-N, L-G, and N-G protection. Adtran also recommends that the device contains a visual 'GOOD' indicator.

Table 3: Regional Plug Adapter Specifications

Region	Power	Connector Type	Certifications
North America	120 VAC @ 60 Hz	NEMA 1-15 Type A, right-angle orientation	cULus Listed
United Kingdom	230 VAC @ 50 Hz	Type G	UKCA and CE compliant
European Union	220 to 240 VAC @ 50 Hz	Type C/F	CE compliant with NB code
Australia/New Zealand	220 to 240 VAC @ 50 Hz	Type I, right-angle orientation	RCM Tick Mark, ERAC Listed

Environmental

- Operating Temperature: 41°F to 104°F (5°C to 40°C)
- Storage Temperature: -13°F to 158°F (-25°C to 70°C)
- Transportation Temperature: -40°F to 158°F (-40°C to 70°C), any humidity
- Operating Humidity: 5 to 85 percent, non-condensing

Compliance

This product meets these compliance requirements:

- US and Canada NRTL Listed
- FCC Part 15, Class B
- FCC Part 2, 2.1091 (MPE)
- ICES-003 (Class B)
- ACMA/RCM
- IEC 62368-1
- EN 62368-1
- AS/NZS 62368.1
- ErP
- RoHS Compliant
- UKCA



NOTE

Changes or modifications not expressly approved by Adtran voids the warranty.

Documentation

You can view Adtran documentation on the Adtran Support Community website after you register at: <https://supportcommunity.adtran.com>.

These online documents and resources provide additional information for this product:

- [SDG SmartOS User Guide](#)
- [SDG General Resources](#)
- Applicable release notes based on firmware

Training

Adtran offers training courses for our products, including customized training and courses taught at our facilities or at customer sites. For inquiries, see <https://adtran.com/training>.

Warranty

Adtran will replace or repair this product within the warranty period if it does not meet its published specifications or fails while in service. Warranty information can be found online at <https://www.adtran.com/warranty>.

Safety and Regulatory



CAUTION

- Connect the DC power input to an approved Limited Power Source (LPS) power supply only.
- This product is intended to operate in ambient temperatures up to 40°C.



NOTE

This product meets these compliance requirements:

- This equipment contains no parts that can be serviced by the user.
- This product meets EU RoHS Directive. See www.adtran.com/environmental for further information on RoHS/WEEE.
- This product is NRTL Safety Listed to the applicable UL/CSA Standards.
- This product has also been evaluated to applicable international standards as indicated by CE, UKCA, and RCM marking.
- The AC branch circuit socket-outlet must be installed near the equipment and must be easily accessible.
- The RJ45 jacks are not used for Voice connections.

Regulatory Compliance

This section includes user requirements for operating this product in accordance with national laws for usage of radio spectrum and operation of radio devices. Your failure to comply with the applicable requirements can result in unlawful operation and adverse action against you by the applicable national regulatory authority.

This product's firmware limits operation to only the channels allowed in a particular region or country. Therefore, all options described in this guide might not be available in your version of the product.

Europe – EU Declaration of Conformity

Products bearing the marking comply with these EU Directives:

- EMC Directive 2014/30/EU I
- Low Voltage Directive 2014/35/EU
- EMC Directive 2014/53/EU
- ErP Directive reference: 2009/125/EC
- RoHS Directive 2015/863/EU
- WEEE Directive reference: 2012/19/EU

Compliance with these directives implies conformity to harmonized European standards that are noted in the EU Declaration of Conformity.

For indoor use only. Valid in all EU member states, EFTA states, and Switzerland.

This device can not be used for setting up outdoor radio links in France and in some areas the RF output power may be limited to 10 mW EIRP in the frequency range of 2454 to 2483.5 MHz. For detailed information, you should contact the national spectrum authority in France.

5150 to 5350 MHz is limited to indoor used in these countries:

BE	BG	CZ	DK	DE	EE	IE	EL	ES	FR	HR
IT	CY	LV	LT	LU	UK	MT	NL	AT	PL	PT
RO	SI	SK	FI	SE	UK(NI)	LI	IS	NO	TR	CH

FCC Requirements for Operation in the United States

FCC Information to User

This product does not contain any user serviceable components and is to be used with approved antennas only. Any product changes or modifications will invalidate all applicable regulatory certifications and approvals.

FCC Guidelines for Human Exposure

This equipment complies with FCC radiation exposure limits set forth for an uncontrolled environment. This equipment should be installed and operated with minimum distance of 31 cm between the radiator and your body.

This device must not be co-located or operating in conjunction with any other antenna or transmitter except in accordance with FCC multi-transmitter product procedures.

FCC Declaration of Conformity

This device complies with Part 15 of the FCC rules. Operation is subject to these two conditions:

- This device may not cause harmful interference, and
- This device must accept any interference received, including interference that may cause undesired operation.

FCC Radio Frequency Interference Warnings and Instructions

This equipment has been tested and found to comply with the limits for a Class B digital device, pursuant to Part 15 of the FCC Rules. These limits are designed to provide reasonable protection against harmful interference in a residential installation. This equipment generates, uses and can radiate radio frequency energy and, if not installed and used in accordance with the instructions, may cause harmful interference to radio communications. However, there is no guarantee that interference will not occur in a particular installation. If this equipment does cause harmful interference to radio or television reception, which can be determined by turning the equipment off and on, you are encouraged to try to correct the interference by one or more of these measures:

- Reorient or relocate the receiving antenna.
- Increase the separation between the equipment and receiver.
- Connect the equipment into an outlet on a circuit different from that to which the receiver is connected.
- Consult the dealer or an experienced radio/TV technician for help.

The specification for this product also lists FCC CFR Part 2, 2.1091 (MPE).

The operation of this device is prohibited on oil platforms, cars, trains, boats, and aircraft, except that operation of this device is permitted in large aircraft while flying above 10,000 feet.

CAN ICES-3(B)/NMB-3(B)

Canadian Department of Communications Radio Interference Regulations

This digital apparatus (Wi-Fi 6 2.5G Router Model SDG-8612 and SDG-8614) does not exceed the Class B limits for radio-noise emissions from digital apparatus as set out in the Radio Interference Regulations of the Canadian Department of Communications.

Industry Canada

This device complies with RSS-247 of the Industry Canada Rules.

Operation is subject to these two conditions:

1. This device may not cause harmful interference, and
2. This device must accept any interference received, including interference that may cause undesired operation.



CAUTION

Radiation Exposure Statement: This equipment complies with IC radiation exposure limits set forth for an uncontrolled environment. This equipment should be installed and operated with minimum distance 31 cm between the radiator and your body.

**ATTENTION**

Déclaration d'exposition aux radiations: Cet équipement est conforme aux limites d'exposition aux rayonnements IC établies pour un environnement non contrôlé. Cet équipement doit être installé et utilisé avec un minimum de 31 cm de distance entre la source de rayonnement et votre corps.

This radio transmitter (IC: 2250A-17600070F1) has been approved by Industry Canada to operate with these antenna types. Antenna types not included in this list are strictly prohibited for use with this device.

- RSS-102 (MPE)

**CAUTION**

- i. The device for operation in the band 5150 to 5250 MHz is only for indoor use to reduce the potential for harmful interference to co-channel mobile satellite systems;
- ii. The maximum antenna gain permitted for devices in the band 5725 to 5850 MHz shall be such that the equipment still complies with the EIRP limits specified for point-to-point and non-point-to-point operation as appropriate.
- iii. The worst-case tilt angle(s) necessary to remain compliant with the EIRP elevation mask requirement set forth in Section 6.2.2(3) shall be clearly indicated.
- iv. Users should also be advised that high-power radars are allocated as primary users (i.e. priority users) of the bands 5250 to 5350 MHz and 5650 to 5850 MHz and that these radars could cause interference and/or damage to LE-LAN devices.

**ATTENTION**

- i. les dispositifs fonctionnant dans la bande 5150-5250 MHz sont réservés uniquement pour une utilisation à l'intérieur afin de réduire les risques de brouillage préjudiciable aux systèmes de satellites mobiles utilisant les mêmes canaux;
- ii. le gain maximal d'antenne permis pour les dispositifs utilisant les bandes de 5250 à 5350 MHz et de 5470 à 5725 MHz doit être conforme à la limite de la p.i.r.e.;
- iii. le gain maximal d'antenne permis (pour les dispositifs utilisant la bande de 5725 à 5850 MHz) doit être conforme à la limite de la p.i.r.e. spécifiée pour l'exploitation point à point et l'exploitation non point à point, selon le cas;
- iv. les pires angles d'inclinaison nécessaires pour rester conforme à l'exigence de la p.i.r.e. applicable au masque d'élévation, et énoncée à la section 6.2.2 3), doivent être clairement indiqués.

Australia/New Zealand - ACMA/RCM

AS/NZS CSFR 32, Class B (EMC), AS/NZS 4268 (RF), RCM mark with R-NZ

North America	United Kingdom	European Union	Adtran Customer Care
Adtran, Inc. 901 Explorer Blvd Huntsville, AL 35806	ADVantage House Tribune Way Clifton Moor York YO30 4RY United Kingdom	Campus Martinsried Fraunhoferstraße 9a 82152 Martinsried/Munich Germany	From within the U.S. 1.888.423.8726 From outside the U.S. +1 256.963.8716 Pricing and Availability 1.800.827.0807

Brand names and product names included in this document are trademarks, registered trademarks, or trade names of their respective holders.
Copyright © 2025 Adtran, Inc. All Rights Reserved.